

QUALITY · INNOVATION · VALUE

AOPEC

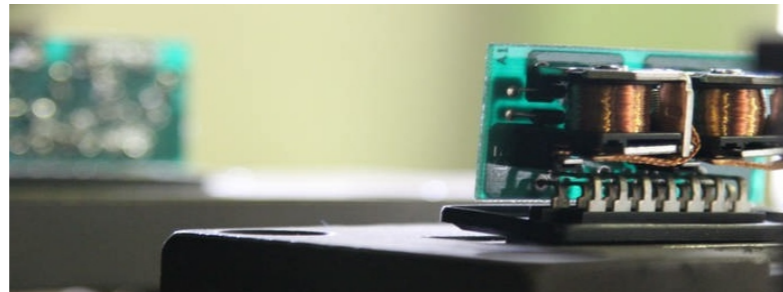
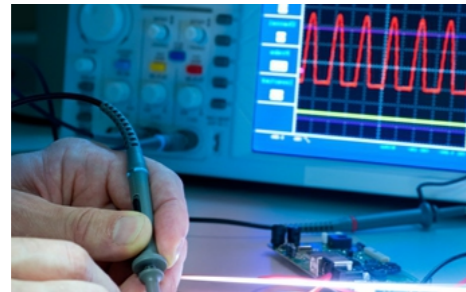

www.aopec.com

AOPEC AUTO PARTS COMPANY

No.2615 Huanqing Rd.
Kunshan Suzhou 215300 China
Tel: +86 512 8616 0118
E-mail: sales@aopec.com

- | AUTO. ELECTRONICS
- | HEATING-COOLING PARTS
- | SENSORS & SWITCHES
- | STARTERS & ALTERNATORS
- | STEERING & SUSPENSION PARTS



COMPANY PROFILE

Aopec Group set up in the year of 2002 and located at No. 2615, Huangqing Road, National High-tech Development Zone, Kunshan City. It now owns three subsidiaries, Suzhou Aopec Automotive Parts Co.,Ltd, Suzhou Aopec Import and Export Co.,Ltd, and Aopec USA LLC. Its products are widely applied in automotive vehicle, engineering machinery, marine and other fields.

Suzhou Aopec Automotive Parts Co.,Ltd is a manufacturer of automotive electronics, producing auto relays, flashers, isolators, and smart chargers. Its products have been approved by IATF16949. Nowadays, the company is cooperating with Shanghai University of Engineering Science, Establishing a joint laboratory for automotive electronics. It has a professional engineers team specializing in research and development of automotive electronics products. AOPEC adopts advanced 3D software SE, Pro/E, PCB Layout Altium Designer technology and dust-free production environment to ensure product quality, to improve product reliability, to lead in the industry.

Suzhou Aopec Import & Export Co., Ltd is a trading company that sources and trades all kinds of auto parts and accessories. automotive battery accessories, heating-cooling, sensors and switches, starter and alternators, chassis parts, spark plugs, ignition coils, rubber parts, etc.

Aopec USA LLC is mainly about warehousing-type sales & distribution, registered in California in April 2013. Providing Local warehouse sales, instant service, and online ordering on Amazon.com.

Now, AOPEC is becoming a base for diversified research and production, we look forward to cooperating and growing with global partners together.



AOPEC TIMELINE

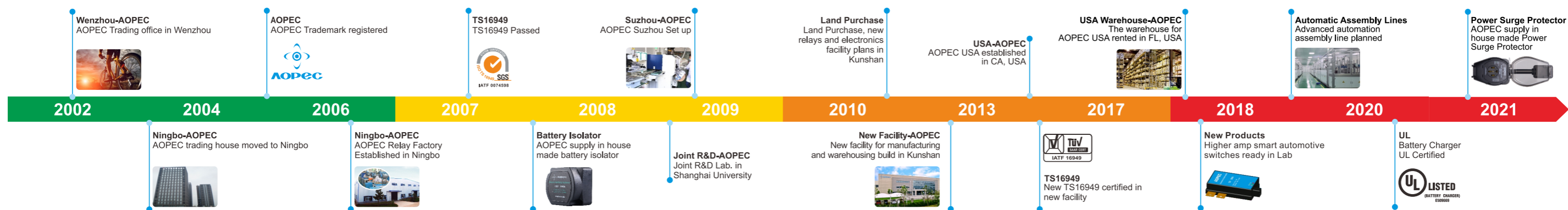

WE ARE SERVING



QUALITY CONTROL & CERTIFICATES



IATF



CE



RoHS

Production Equipments



CNC machine

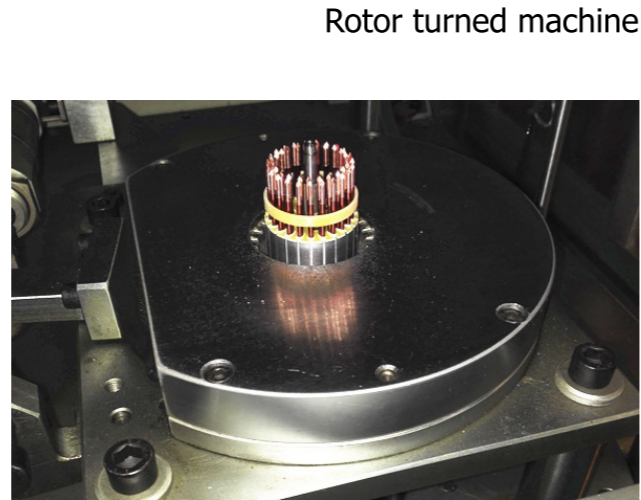

Rotor turned machine

Starter & Alternator Work shop



Alternator semi - automatic assembly line

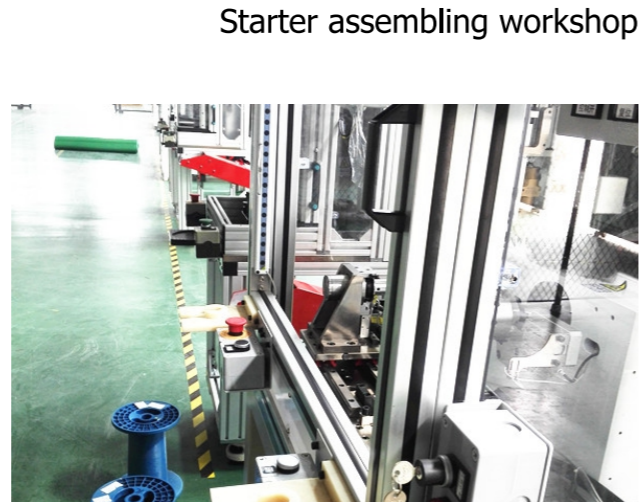

Starter assembling workshop

QUALITY CONTROL



- DV test
- Salt spray test



Heating-Cooling Inspection



Automotive Relays

ISO MINI RELAY
708



ISO MICRO RELAY
709



ISO POWER RELAY
811



ISO MINI RELAY
711



280 MICRO RELAY
739



ISO MINI SOLID STATE RELAY
790

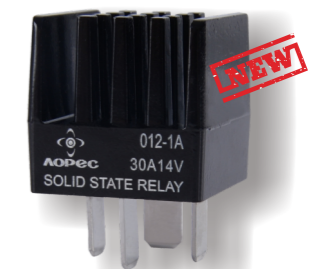

ISO MICRO SOLID STATE RELAY
791



HIGH CURRENT RELAY
792



ISO MINI SILENT RELAY
793



Automotive Relays

Aopec automotive relay is widely applied to several controlling systems of automobile, have Mini relay, Micro relay, HD relay, PCB relay.

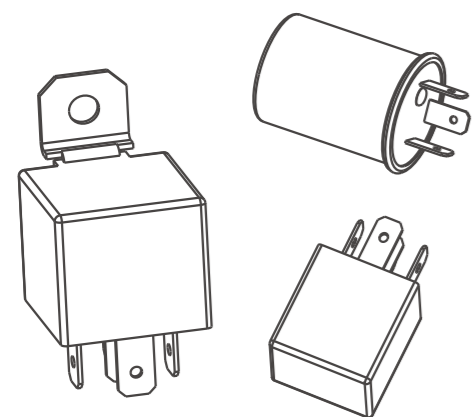

Features:

- Heavy duty and performance relays are available from 20amp to 100 amps
- Ratings in 6, 12, 24 and 48 volt applications
- Extended temperature range to 250 degrees F or 125 degrees C
- Unlimited range of contact patterns are available
- Sealed IP67 and dust cover versions are available
- Manufactured with Transient Suppression Resistors
- ROHS, ELV, and UL compliant

Automotive Relays

Part Number	Rated Voltage	Contact Arrangement	Description	Current	Coil Power Consumption
HOT 708	12V	4 Pins (1A/1H)	708 12V 1A	NO:40A	1.6W
708	12V	5 Pins (1C/1Z)	708 12V 1C	NO:40A;NC:30A	1.6W
708	24V	4 Pins (1A/1H)	708 24V 1A	NO:20A	1.8W
708	24V	5 Pins (1C/1Z)	708 24V 1C	NO:20A;NC:15A	1.8W
709	12V	4 Pins (1A/1H)	709 12V 1A	NO:30A	1.6W
709	12V	5 Pins (1C/1Z)	709 12V 1C	NO:20A;NC:10A	1.6W
709	24V	4 Pins (1A/1H)	709 24V 1A	NO:15A	1.8W
709	24V	5 Pins (1C/1Z)	709 24V 1C	NO:10A;NC:5A	1.8W
811	12V	4 Pins (1A/1H)	811 12V 1A	NO:70A	1.6W
811	12V	5 Pins (1C/1Z)	811 12V 1C	NO:70A;NC:40A	1.6W
811	24V	4 Pins (1A/1H)	811 24V 1A	NO:40A	1.8W
811	24V	5 Pins (1C/1Z)	811 24V 1C	NO:40A;NC:20A	1.8W
711	12V	4 Pins (1A/1H)	711 12V 1A	NO:40A	1.6W
711	12V	5 Pins (1C/1Z)	711 12V 1C	NO:40A;NC:30A	1.6W
711	24V	4 Pins (1A/1H)	711 24V 1A	NO:20A	1.8W
711	24V	5 Pins (1C/1Z)	711 24V 1C	NO:20A;NC:15A	1.8W
739	12V	4 Pins (1A/1H)	739 12V 1A	NO:40A	1.6W
739	12V	5 Pins (1C/1Z)	739 12V 1C	NO:40A;NC:30A	1.6W
739	24V	4 Pins (1A/1H)	739 24V 1A	NO:20A	1.8W
739	24V	5 Pins (1C/1Z)	739 24V 1C	NO:20A;NC:15A	1.8W
790	12V	4 Pins (1A/1H)	790 12V 1A	30A	0.1W
791	12V	4 Pins (1A/1H)	791 12V 1A	10A	0.1W
792	12V	4 Pins (1A/1H)	792 12V 1A	300A	4W
792	24V	4 Pins (1A/1H)	792 24V 1A	150A	4W

Automotive Flashers

AUTOMOTIVE FLASHER 601



AUTOMOTIVE FLASHER 604



AUTOMOTIVE FLASHER 609



AUTOMOTIVE FLASHER 610



AUTOMOTIVE FLASHER 662



AUTOMOTIVE FLASHER 663



Part Number	Rated Voltage	Max Load	Main Lamp Load	Auxiliary Lamp Load	Alarm
HOT 601	12V	98W	4X21W	2X5W	Alarm
604	12V	98W	4X21W	2X5W	Alarm
609	12V	98W	4X21W	2X5W	Alarm
610	12V	98W	4X21W	2X5W	Alarm
662	12V	98W	4X21W	2X5W	No Alarm
663	12V	98W	4X21W	2X5W	No Alarm



Smart Battery Isolators Extend Battery Life

Features

- Outstanding Features**

12V 140A; 24V 100A
Standby Current:
12V--<3mA; 24V--<6mA
Surge Protect
LED Indicator
Dustproof

- Printed Circuit Board**

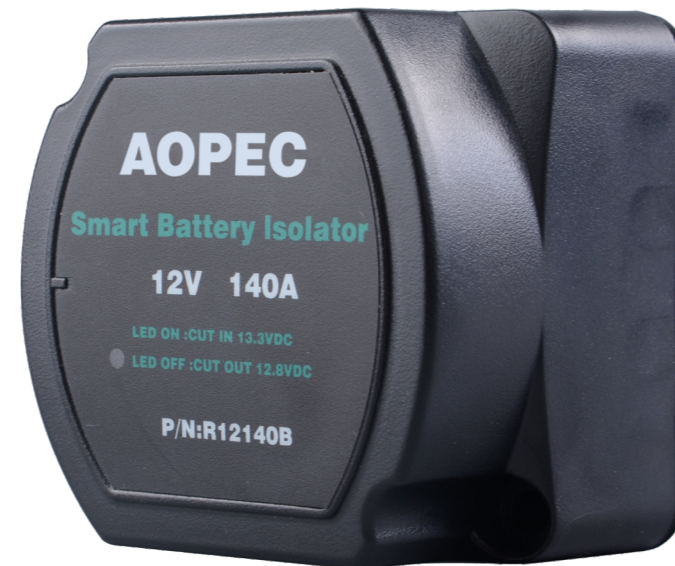
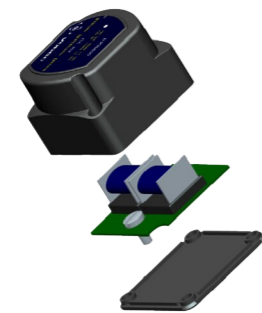

- Using Our Own Made Relay**



Main Technical Data

HOT	Part Number	Rating Voltage	Continous Current	Cut-in Voltage	Cut-out Voltage	Intermittent Current
	R12140A	12V	140A	13.7V	12.8V	170A
	R24100A	24V	100A	27.4V	25.6V	140A
	R12140B	12V	140A	13.3V	12.8V	170A
	R12140B-1	12V	140A	13.3V	12.65V	170A
	R24100B	24V	100A	26.6V	25.6V	140A
	R12140C	12V	140A	13.7V	12.8V	170A
	R12140E	12V	140A	13.2V	12.7V	170A

Smart Battery Isolators

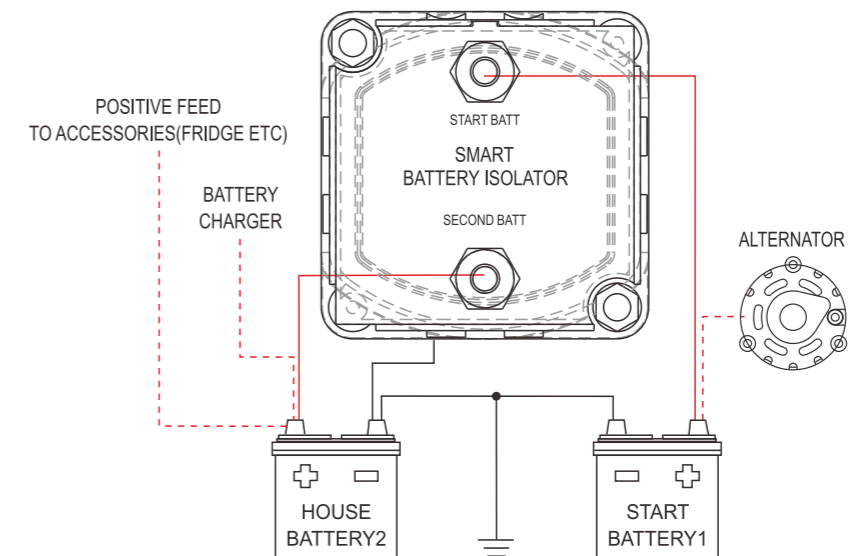

Dual Battery Kits

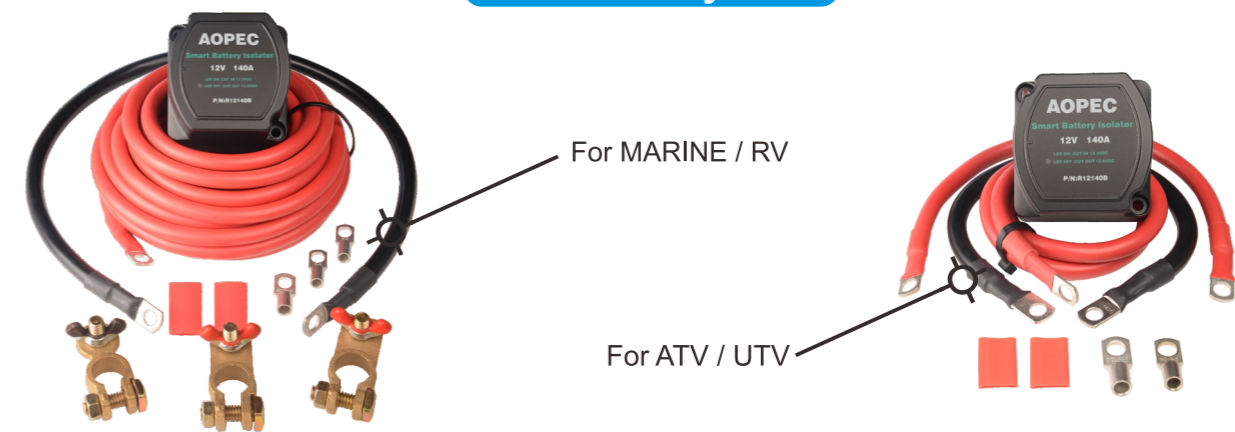

Perfect For

○ Designed for dual battery systems

○ Suitable for most 12V/24V charging systems



RV



ATV / UTV



Special police vehicles



OFF ROAD



MARINE



Smart Battery Isolator

New Model Heavy Current



Outstanding Features

- 12V 200A; 12V 300A
- Designed for dual battery system
- For 12V charging system
- Surge protection
- Easy to install

Product Series

Part Number	Rated voltage	Rated current	Gap current	Cut in	Cut out
R12140A	12V	140A	170A	13.7V	12.8V
R24100A	24V	100A	140A	27.4V	25.6V
R12140B	12V	140A	170A	13.3V	12.8V
R24100B	24V	100A	140A	26.6V	25.6V
R12140C -1/R12140C -2	12V	140A	170A	13.7V	12.8V
R24100C -1/R24100C -2	24V	100A	140A	27.4V	25.6V
R12140E	12V	140A	170A	13.2V	12.7V
Part Number	Rated voltage	Rated current	Peak current	Cut in	Cut out
R12300A	12V	200A	400A	13.8V	13.3V
R12300B	12V	300A	500A	13.3V	12.8V

Smart Battery Isolator

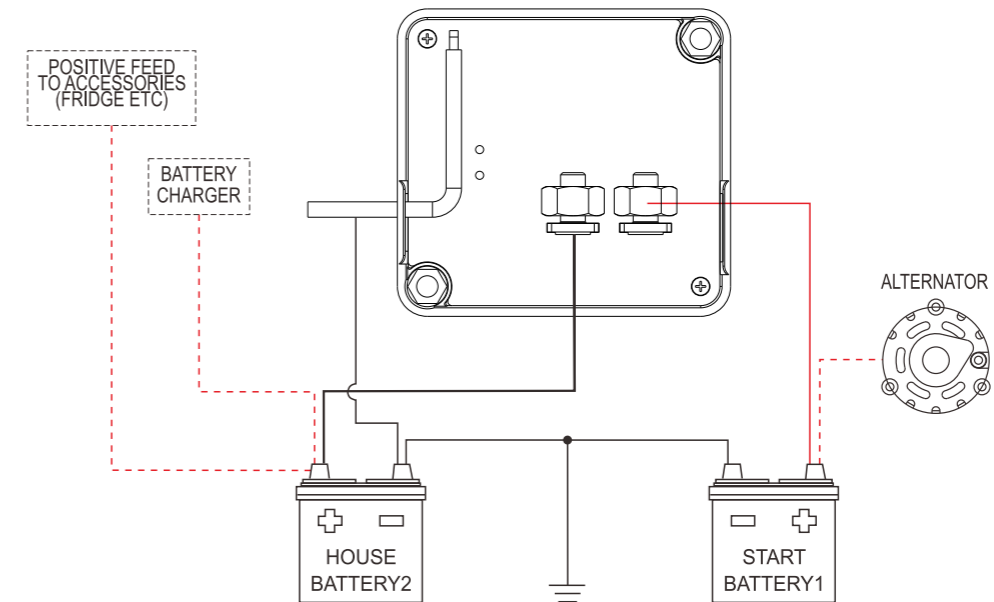

How Does It Work?

When the voltage of start battery is higher than cut-in volts, the smart battery isolator (SBI) keeps engaging, two batteries (start and house) are charged simultaneously. Unit Indicator (LED) is on.

When the batteries no longer have a charge from the alternator, and loads on the batteries begin to deplete them. Unit Indicator (LED) is on.

When the voltage drops below cut-off volts for 5 seconds, the SBI senses it and disengages, separating both batteries. Unit Indicator (LED) is off.

When the vehicle is restarted, the start battery has reached the cut-in volts, the SBI engaged again. Unit Indicator (LED) is on.

Applications

- Designed for dual battery system
- Suitable for most 12V/24V charging systems

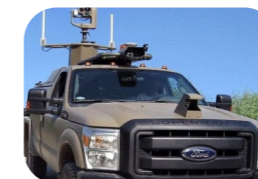



Better protection for your appliance;
Better safeguard for your property.

Newly-Designed Outlook

Our surge protector adopts the latest appearance design, making it more convenient to use.

Power Surge Protector

Multi-application surge protector with pedestal tester. The all-in-one surge protectors are portable devices that have both surge protection and pedestal testing in one unit. Simply plug the device into the power pedestal to check the quality of your power and then plug in your cordset. You can continue to monitor the quality of power while your RV is connected and surge protected.

Quick Details

Model Number: PSP-50A

Rated Current: 50A

Rated Voltage: 120V / 240V

Frequency: 60HZ

Total Surge Suppression: 4200J

Max Current: 6500A

Maximum Watts: 12000W

Easy Installation

Anti-Theft Design



Plug handle:
Easy to pull out the plug,
beautiful and sturdy.

Anti-theft ring: You can attach
the cable to the charging pile
by the pull ring, the tough material
and high quality promise the safety
of your surge protector. Achieve
anti-theft function.

Completely new design saves at
least 1/3 room compared with the
ordinary surge protector. Meanwhile,
the style of the surge protector
perfectly matches the other
products in the same series.

Sheathed cable: Waterproof hard wires
prevent the water penetration, and provide
the most effective surge protection.

Removable protective cover:
On rainy days, you can install the
cover on the surge protector;
On sunny days, you can take it
down to save more room.

Part Number	Rated Current/ Rated Voltage	Total Surge Suppression	Max Current	Indication	Faults	Weatherproof Cover Included	UL Certified
PSP - 30A	30A,120V	2100J	6500A	Integreted LEDs	Open Hot Indication Open Neutral Protection Open Ground Protection Reverse Polarity Protection	✓	✓
PSP - 50A	50A 120/240V	4200J	6500A	Integreted LEDs	Open Hot Indication Open Neutral Protection Open Ground Protection Reverse Polarity Protection	✓	✓



Battery Chargers

Battery Chargers

Your Batteries' Doctor

AOPEC Chargers give you a revolution in battery charging technology. Its multiple stage desulfation, charging and analysis ensures a fully charged and well maintained battery every time. AOPEC chargers are compact and durable, allowing it to operate in a compact, dusty, and humid environment. The product has passed UL certification ULNo.E50969.

Main Technical Data

Part Number	Input Voltage	Input Frequency	Charging Voltage	Output Current	Dimensions (inch)	Operating Temperature
BC12075	120VAC	50/60Hz	14.4VDC	0.75A MAX	4.02*1.97*1.22	-4°F~104°F
BC12125	120VAC	50/60Hz	14.4VDC	1.25A MAX	4.02*1.97*1.22	-4°F~104°F
BC12200	120VAC	50/60Hz	14.4VDC	2A MAX	4.02*1.97*1.22	-4°F~104°F

Part Number	Charging Stage	Battery Reverse Connection Protection	Surge Protection	Over-voltage Protection	Short-circuit Protection
BC12075	5	✓	✓	✓	✓
BC12125	5	✓	✓	✓	✓
BC12200	5	✓	✓	✓	✓

Functional Characteristics

- MCU- controlled
- 5-Step charging process
- LED charge steps display
- Error warning
- Surge protecton
- Battery reverse polarity protecton
- Over-voltage protecton
- Over-current protecton
- Short-circuit protecton



UL Certification



Easy To Use



Quick-disconnection



Perfect For



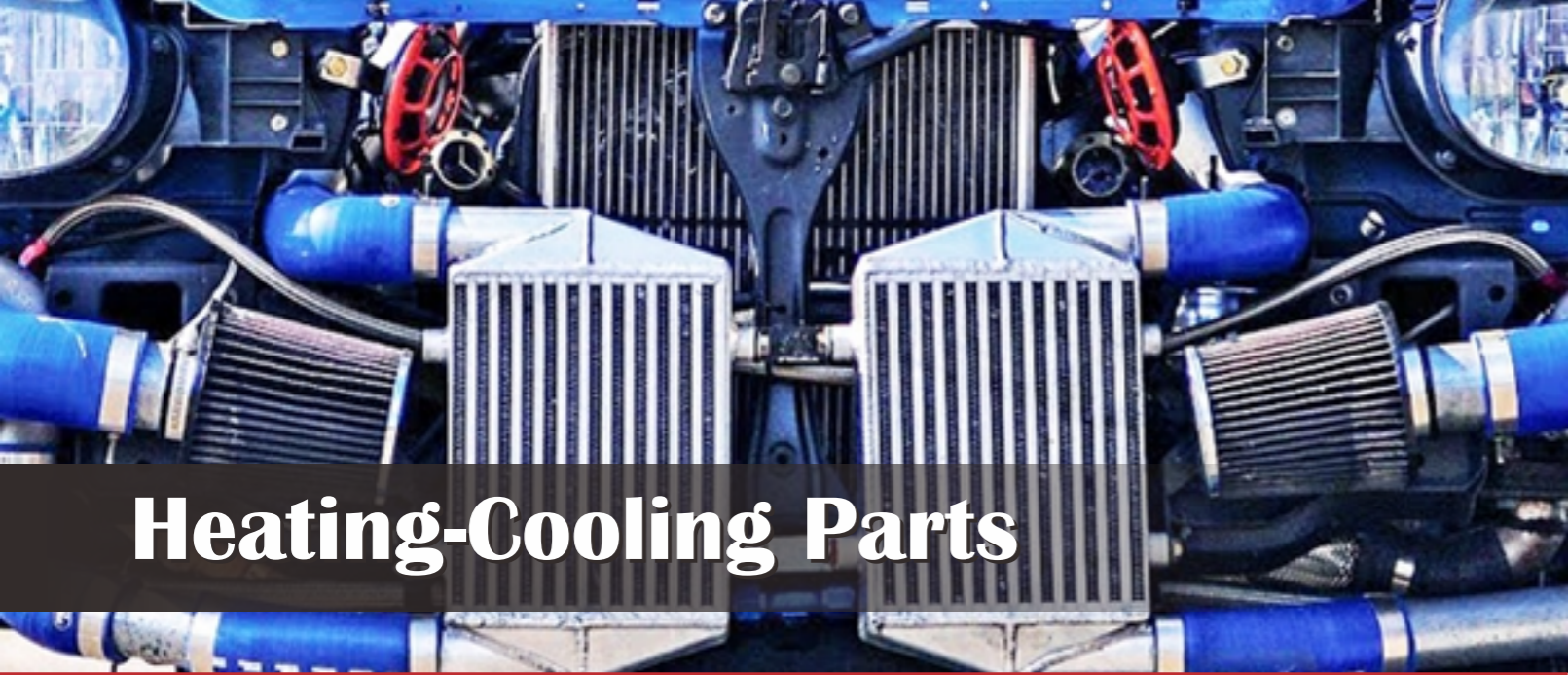

Heating-Cooling Parts

Product Category

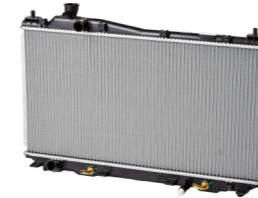

◆ RADIATORS



◆ HEATER CORES

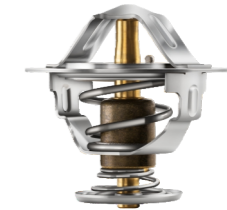

◆ THERMOSTATS



◆ RECEIVER DRYERS



◆ EVAPORATORS



◆ EXPANSION VALVES



◆ OIL COOLERS



◆ INTERCOOLERS

EXCLUSIVE MODELS



Heater Core
OE No.: 6R099S031



Heater Core
OE No.: 6448X8



Heater Core
OE No.: 4677138



Thermostat Assembly
OE No.: 49012024F



Thermostat Assembly
OE No.: 55202883

Features

- 100% New Components
- More Than 2000 SKUs Available
- Small MOQ Request
- OEM & ODM Services
- Timely Delivery Date
- Exclusive Models Available
- International Supply Chain Management
- Quality Control & Management

Project	AOPEC Item No.	OE Brand 1	OE Brand 1 Item No.	OE Brand 2	OE Brand 2 Item No.
Thermostat	1313-00-007	RENAULT	7701348068	DACIA	7701348068
Thermostat	1313-00-043	FIAT	7729959		
Thermostat	1313-00-072	CHRYSLER	49012024F		
Heater core	1316-00-065	FORD	1740613		
Heater core	1316-00-068	RENAULT	271154491R	DACIA	
Heater core	1316-00-070	OPEL	13287939		271154491R
Heater core	1316-00-091	OPEL	6448X8	FIAT	6448T3
Heater core	1316-00-092	MERCEDES-BENZ	0038350001		
Heater core	1316-00-093	IVECO	504026720		
Heater core	1316-00-094	IVECO	3802174		
Intercooler	1317-00-039	RENAULT	144963014R	DACIA	144963014R
Intercooler	1407-00-041	OPEL	93868349	RENAULT	144960050R
...

Project	AOPEC Item No.	OE Brand 1	OE Brand 1 Item No.	OE Brand 2	OE Brand 2 Item No.
Radiator	1308-00-053	OPEL	93277988		
	1308-00-085	VW	4B0121251G	AUDI	8D0121251Q
Thermostat	1313-00-168	OPEL	1338870	DAEWOO	90200836
	1313-00-087	VW	032121110B	AUDI	032121110B
Heater core	1316-00-060	VW	7M1819030	FORD	7M1819030
	1316-00-064	RENAULT	7701045552		
Oil cooler	1407-00-031	OPEL	97223705		
	1407-00-033	VW	1252913	FORD	068117021B
Intercooler	1317-00-032	VW	058145805A	AUDI	058145805C
	1317-00-029	AUDI	8E0145805F		
Dryer filter	3811-00-029	VW	3B0820191	AUDI	3B0820191
	3811-00-038	MERCEDES-BENZ	1698300058		
Expansion valve	3804-00-010	VW	6N0820679C	AUDI	6N0820679A
	3804-00-007	VW	7H0820679A	AUDI	7H0820679A
Evaporator	3805-00-006	OPEL	1618241		
	3805-00-005	VW	2E0820091B	MERCEDES-BENZ	18309658

CONTACT US FOR MORE



Switches & Sensors

Product Category



◆ LIGHT SWITCHES



◆ IGNITION STARTER SWITCHES



◆ ISOLATOR SWITCHES



◆ PRESSURE SWITCHES



◆ OXYGEN SENSORS



◆ AIR FLOW METERS



◆ PRESS SENSOR



◆ TEMPERATURE SWITCHES



◆ WHEEL SPEED SENSORS

EXCLUSIVE MODELS



Brake light switch
OE No.: 1K0945459A



Brake light switch
OE No.: 9S04S694S0



Exhaust pressure sensor
OE No.: 5519S717



Exhaust pressure sensor
OE No.: 13627805152



Exhaust pressure sensor
OE No.: 110673774RRP

Features

- 100% New Components
- More Than 2000 SKUs Available
- Small MOQ Request
- OEM & ODM Services
- Timely Delivery Date
- Exclusive Models Available
- International Supply Chain Management
- Quality Control & Management

Category	AOPEC Item No.	Reference Brand 1	Reference Brand 1 Item No.	OE Brand 1	OE Brand 1 Item Number
Diverter valve	1226-00-001	SIDAT	81180	VW	06F145710C
Intake manifold pressure sensor	3101-00-117	FAE	15028	BMW	7787142
Exhaust pressure sensor	1313-00-227	EPS	1993277	FORD	AB395L224AA
Reverse light switch	3101-00-155	VEMO	V30730084	MERCEDES-BENZ	2015450014
Door contact switch	3101-00-160	VEMO	V30730135	MERCEDES-BENZ	A0008212852
Coolant temperature sensor	3110-00-399	EPS	1830326	OPEL	55190791
Kraftstofftemperatursensor	3110-00-276	EPS	1830376	VW	038906081B
Camshaft position sensor	1313-00-234	EPS	1953565		
Brake light switch	3110-00-173	EPS	1810058	BMW	61311378208
Brake light switch	3110-00-170	VEMO	V10730097	VW	443945515
Lambda sensor	3101-00-156	NGK	0442	OPEL	855313
Brake light switch	3101-00-159	EPS	1810129	VW	6K0945515A
...

Project	AOPEC Item No.	OE Brand 1	OE Brand 1 Item No.	OE Brand 2	OE Brand 2 Item No.
Lifter switch	3101-00-099	VW	191959855	SEAT	191959855
	1313-00-273	FORD	96FG14529BC		
Light Switch	3110-00-093	VW	02T945415D	FORD	1439597
	3110-00-195	VW	1J0945511A	SKODA	1J0945511C
Ignition Starter Switch	3101-00-090	VW	6N0905865	SEAT	6N0905865
	3101-00-088	OPEL	914863		
Steering switch	3101-00-092	FIAT	1315467080		
	3101-00-080	OPEL	4410525	RENAULT	7701050688
Pressure Switch	3110-00-126	OPEL	1238696	FIAT	55354325
	3110-00-136	MERCEDES-BENZ	71536128	SMART	61539528
Oxygen Sensor	3110-00-356				
	3110-00-354	OPEL	855305	SUZUKI	1821364B00
Air Flow Meter	1222-01-024	VW	038906461C	FORD	1384275
	1222-01-052	OPEL	9110733	RENAULT	H8200259658
Temperature Switch	3101-00-073	VW	059919501AS1	FORD	112477051
	3101-00-072	VW	06A919501AS1	AUDI	6A919501B
Wheel Speed Sensor	3101-00-098	VW	1J0927807B	AUDI	1J0927807B
	3110-00-263	VW	1H0927808	AUDI	1J0927804

CONTACT US FOR MORE



Starters & Alternators SPECIAL FOR RACING

For racing area, all our racing starters and alternators are manufactured especially based on extreme demand.



1

USE HIGH QUALITY RAW MATERIALS, ADVANCED PRODUCTION AND TESTING EQUIPMENT TO KEEP QUALITY.

2

PRODUCT IS USED WIDELY, SUITABLE FOR MOST OF THE MODELS, AND PRODUCTS CAN BE INNOVATED AND UPGRADED CONSTANTLY.



3

GOOD SEALING, HIGH TEMPERATURE-RESISTANCE, CORROSION-RESISTANCE.



Racing



◆ STARTER
150103



◆ STARTER
150104



◆ STARTER
150105

AOPEC Item No.	Reference No.	Description
150101	9100	Permanent Magnet Starter straight mount
150102	9200	Permanent Magnet Starter staggered mount PG260M
150103	9000	Starter straight mnt 160Ft./Lbs
150104	9004	Starter straight mnt 180Ft./Lbs
150105	9600	Starter Straight Mnt 180 Ft.
150106	9612	Starter Staggered Mnt 180 Ft.

CONTACT US FOR MORE



◆ ALTERNATOR
100101



◆ ALTERNATOR
100102



◆ ALTERNATOR
100103

AOPEC Item No.	Reference No.	Description
100101	17127	85A w/1V pulley 10si Chrome
100102	37127	GM alternator 100 Amp Chrome V-Belt 1-wire
100103	7296	GM alternator 100 Amp Natural 6-rib 1-wire
100104	17296	GM alternator 100 Amp Chrome 6-rib 1-wire
100105	47294	GM alternator 140 Amp Natural V-Belt 1-wire
100106	37293	GM alternator 140 Amp Chrome V-Belt 1-wire

CONTACT US FOR MORE

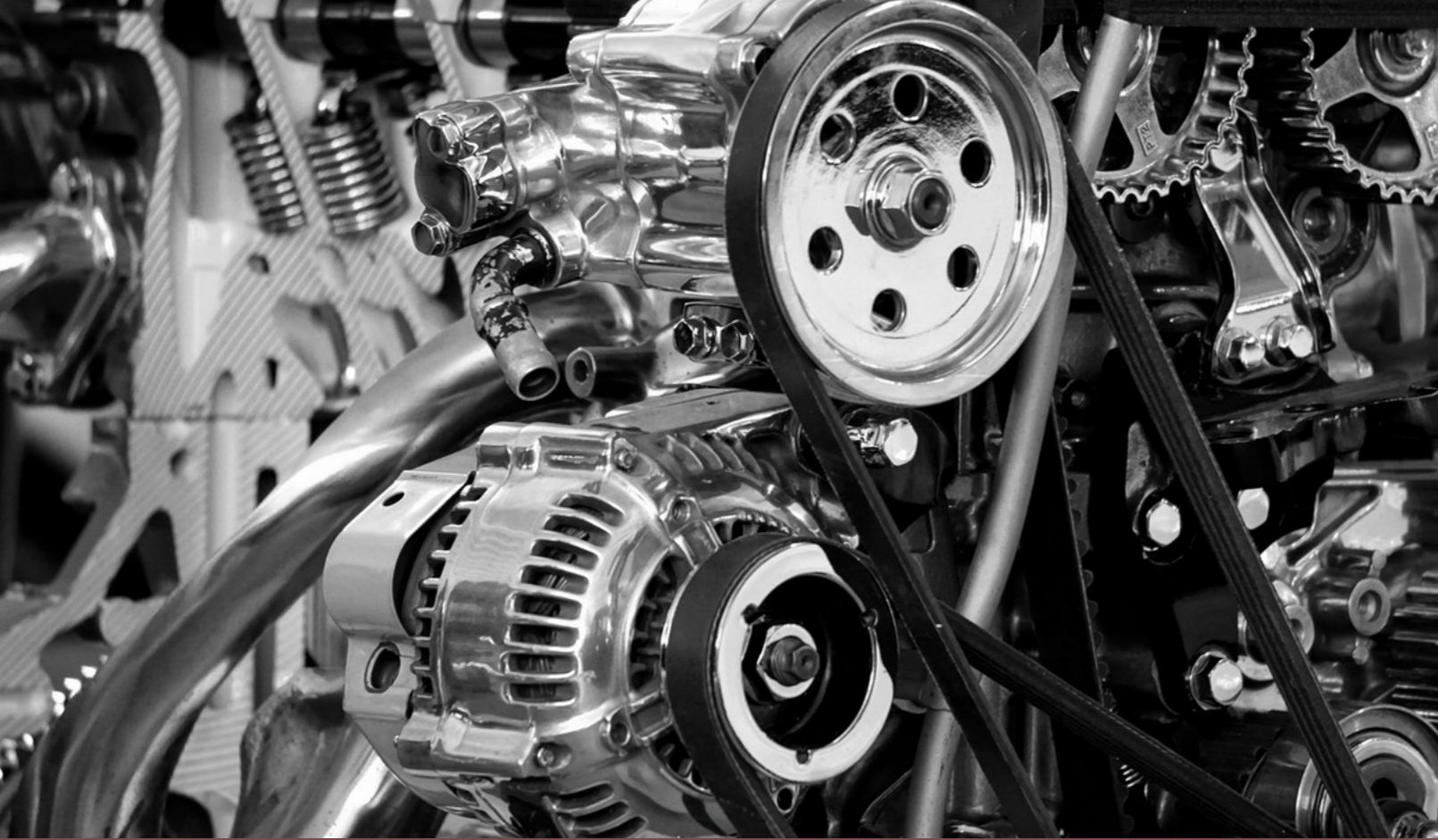

Starters & Alternators

1,500 different parts for Ford, VW, Buick, Jeep, Chevrolet, GMC, Cadillac. Alternators cover 54 families with over 800 items, while starters cover 52 families with 700 items. Aopec also has components from alternators and starters available.

AOPEC Starters & Alternators

- Ford
- VW
- Buick
- Jeep
- Chevrolet
- GMC
- Cadillac



Aftermarket

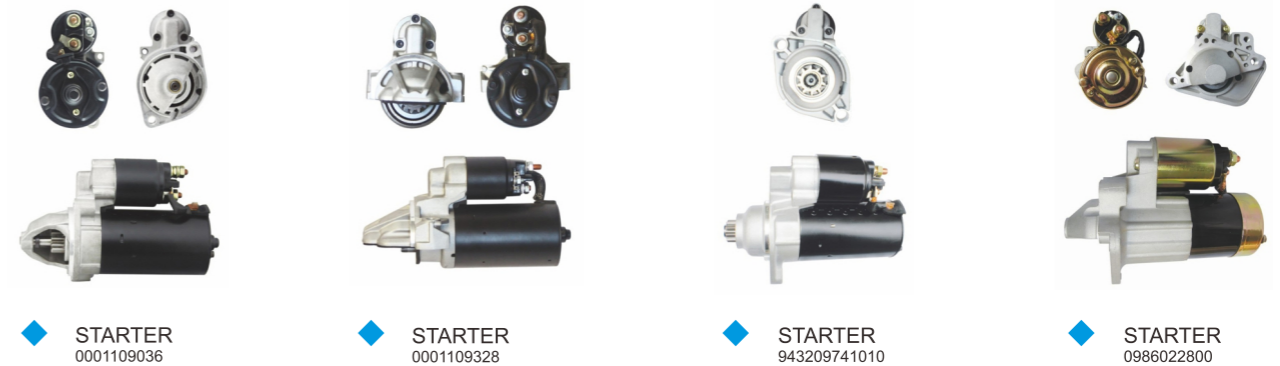

◆ STARTER 0001109036 ◆ STARTER 0001109328 ◆ STARTER 943209741010 ◆ STARTER 0986022800

AOPEC Item No.	Reference Brand 1	Reference Brand 1 Item No.	OE Brand 1	OE Brand 1 Item No.
3302-00-073	BOSCH	986017120	OPEL	90341777
3302-00-066	BOSCH	0986013850	PEUGEOT	9633292480
3302-00-079	BOSCH	0986019361	ISUZU	8971891181
3302-00-045	BOSCH	0986021351	FORD	1096338
3302-00-041	REMY	DRS7120	OPEL	9190838
3302-00-036	REMY	DRS0099	LANCIA	55192482
3302-00-072	BOSCH	0986016990	VAG	02B911023L
3302-00-081	BOSCH	0986020131	RENAULT	8200583014
3302-00-029	VALEO	455928	FIAT	717738330

CONTACT US FOR MORE

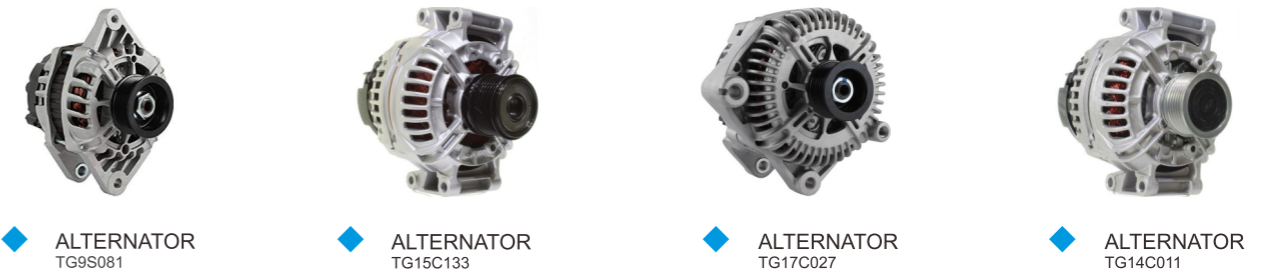

◆ ALTERNATOR TG9S081 ◆ ALTERNATOR TG15C133 ◆ ALTERNATOR TG17C027 ◆ ALTERNATOR TG14C011

AOPEC Item No.	Reference Brand 1	Reference Brand 1 Item No.	OE Brand 1	OE Brand 1 Item No.
ABR8A	LESTER	13932N	VALEO	SG12B011
ABR9A	LESTER	11134N	VALEO	TG14C011
ABR10B2	LESTER	23285R	VALEO	TG15C163
ABR10B3	LESTER	23313N	VALEO	TG15C164
ABR13A	LESTER	11396N	VALEO	TG17C036
ABR13A1	LESTER	11355R	VALEO	TG17C027
ABR13A2	LESTER	23319N	VALEO	TG17C048
ABR14A	LESTER	13209N	VALEO	TG9S081
ABR14A1	LESTER	11471N	VALEO	TG9S075

CONTACT US FOR MORE



Steering & Suspension Parts



◆ BALL JOINTS



◆ CONTROL ARMS



◆ STABILIZER BARS



◆ PITMAN ARMS



◆ TIE ROD ENDS



◆ RACK ENDS



◆ COIL SPRINGS



◆ BUSHINGS

Steering & Suspension Parts

We have full testing machines to make sure high quality of each suspension part. The parts are tested to ensure they meet and maintain the required specifications. We also performs fatigue testing and hardness testing using state of the art testing equipment.

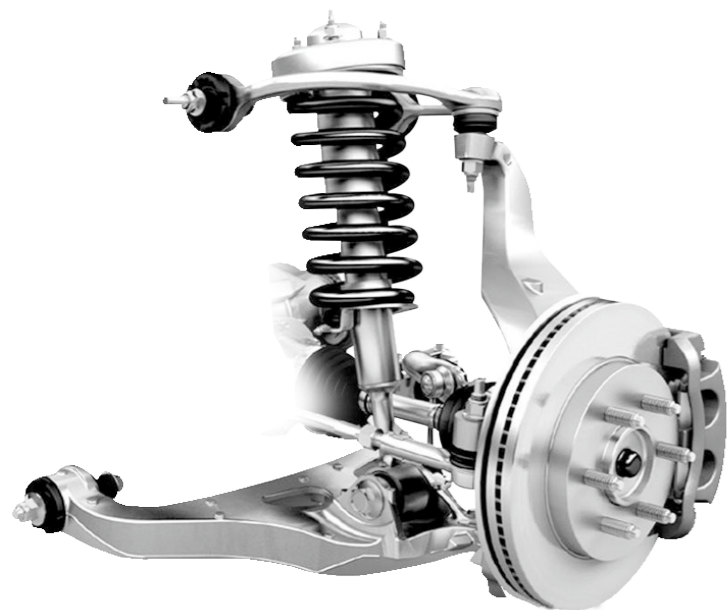

Features:

- 100% New Components
- More Than 2000 SKUs Available
- Small MOQ Request
- OEM & ODM Services
- Timely Delivery Date
- Exclusive Models Available
- International Supply Chain Management
- Quality Control & Management

Project	AOPEC Item No.	Reference Brand	References	OE Brand 1	OE Brand 1 Reference No.
Ball Joint	2111-11-014	MEYLE	16-16 010 4264	RENAULT	7701462182
	2111-01-044	MEYLE	116 010 7154	VW	357407365
	2111-05-018	MEYLE	616 010 5583	OPEL	00352800
Stabiliser Bar	2211-22-006	MEYLE	616 060 0003/HD	GM	13169439
	2211-01-009	MEYLE	116 060 0000/HD	VW	6C0411315
	2211-41-035	MEYLE	716 060 0090/HD	MAZDA	1E00-34-170
Tie Rod Axle Joint	2120-05-004	MEYLE	616 031 0014	CHEVROLET	26059293
	2120-02-002	MEYLE	116 030 8504	VW	1J0422803E
	2120-10-006	MEYLE	11-16 031 0015	PEUGEOT	1607293680
Tie Rod End	2111-01-030	MEYLE	116 020 7106	VW	191 419 812
	2111-02-009	MEYLE	116 020 0008/HD	VW	4F0 498 811
	2111-05-009	MEYLE	616 020 0001	SMART	451 338 0037
Control Arm	2208-05-030	MEYLE	616 050 0026	SUZUKI	45200-76G20
	2208-02-070	MEYLE	116 050 8298/HD	VW	4Z7 407 506 A
	2208-02-073	MEYLE	116 050 8293/HD	VW	4D0 407 510 J
Project	AOPEC Item No.	Reference Brand1	References 1	Reference Brand 2	References 2
Coil Spring	6404-00-011	ROC	CS3729	MONROE	SP2792
	6404-00-035	ROC	CS3653	MONROE	SP0033
	6404-00-170	ROC	CS4478	MONROE	SP3386

CONTACT US FOR MORE



Battery Accessories



◆ BATTERY CABLES



◆ BATTERY TERMINALS



◆ BATTERY HOLD DOWN KITS



◆ BATTERY INSULATORS



◆ BOOSTER CABLES & CLAMPS

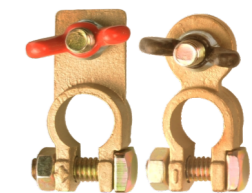

◆ BATTERY CLAMPS

Battery Accessories

We have just the right accessories for the job!

Features:

- Universal applications for all types of batteries.
- Full line of products to provide a full range of protection for your battery.
- Specially designed for maximum flexibility and easy installation.



Cable & Wires

AOPEC has a comprehensive offerings of wire and cable products for automotive, marine, commercial, lawn & garden, Rv, trailers, and many more applications. The ISO-9001 certified factory guarantees every process including incoming material, in process and finished goods, along with in house testing remain at the highest level ensuring the highest quality goods are delivered to you.

Other Battery Accessories

AOPEC selection of battery accessories is the perfect counterpart to your battery line. Our products are available pre-packaged for retail display or in bulk and include battery terminals, battery cables, booster cables, clamps and much more.

Perfect For

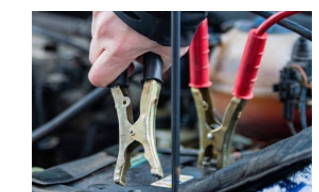
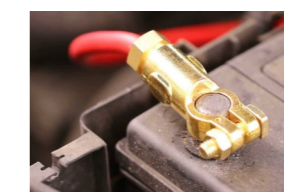



Smart Switches

New Energy Vehicle

Functional Characteristics

- Ground Short Circuit Protection
- Over-voltage, Under-voltage Protection
- Current Overload, Over-temperature Protection
- Load Capability: Continuous Current 200A, Peak Current:400A
- One-way Flow of Current, with Reverse Cut-off Function
- Current, Temperature, Voltage Detection
- Operating Temperature: -40~+125℃
- IP Level: IP 67
- Safety Level: ASIL B

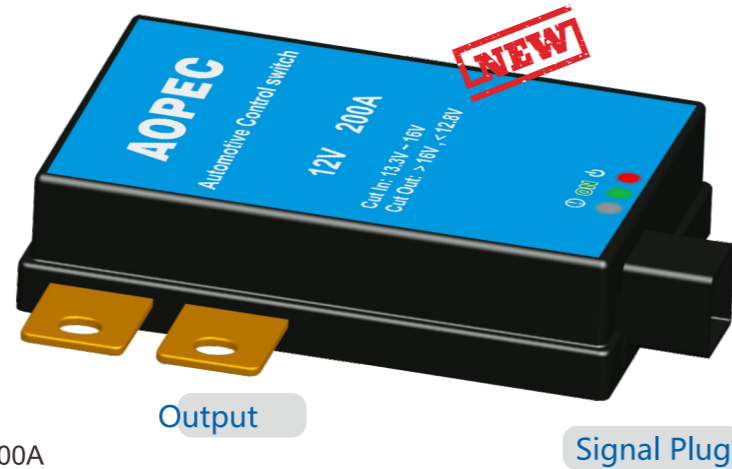

Output

Signal Plug

Product Series

Model	Rated Voltage	Rated Current	Reverse Blocking
A1280Z	12V	80A	Y
A1290Z	12V	90A	Y
A12120	12V	120A	N
A12200	12V	200A	N
A2480Z	24V	80A	Y
A24100	24V	100A	N

Automotive Control Switches

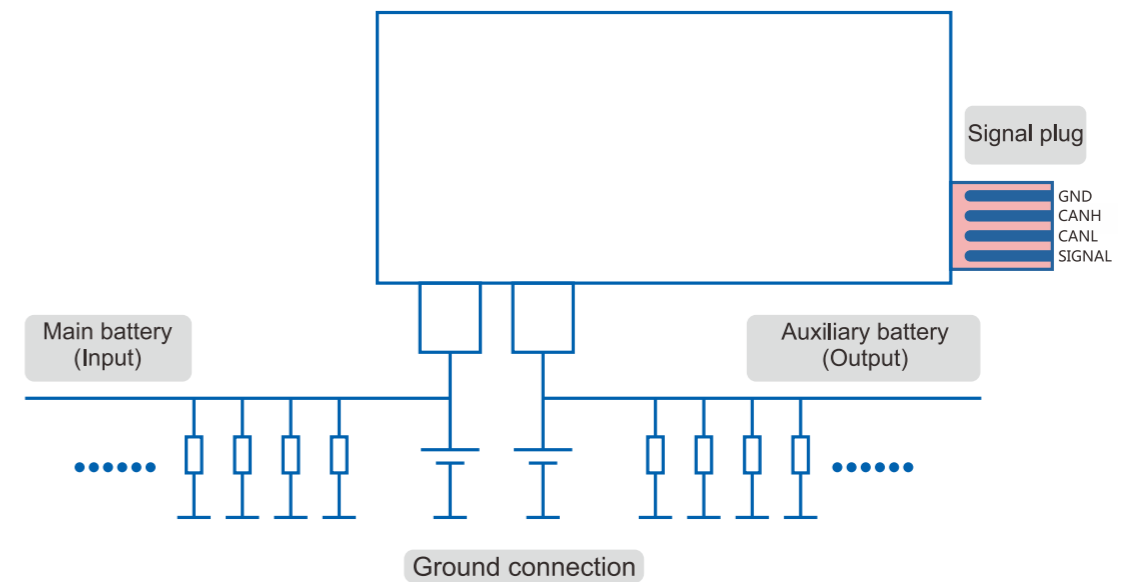

Working Principle

The dual battery circuit management smart switch controls the isolation and conduction of the dual battery circuitry by monitoring the battery voltage.

Smart switch working mode (conduction): When the monitoring voltage is within the set range value, the smart switch is automatically turned on, at this time, it is in the working mode, and the two battery systems are connected in parallel.

Smart switch standby mode (isolated): When the monitoring voltage exceeds the set range value, the smart switch is automatically disconnected. At this time, it is in standby mode, and the two battery systems are isolated.

Perfect For

- Designed for dual battery systems
- Suitable for most 12V/24V charging systems



RV



ATV / UTV



New Energy Vehicle



OFF ROAD



MARINE